

Обозначение блока	Выходной сигнал, мА	Рис. для				
		Б	В	Г	Д	Е
БПС-90П	0 - 5	-	-	-	4	-
	0 - 20	-	2	3	4	-
	4 - 20	-	2	-	5	6
БПС-90К	0 - 5	1	-	-	4	-
	0 - 20	1	2	3	4	-
	4 - 20	1	2	-	5	6

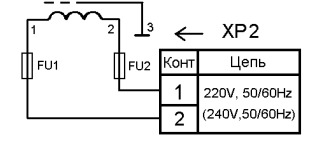
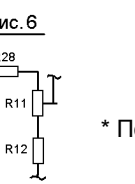
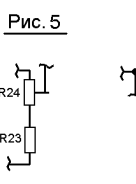
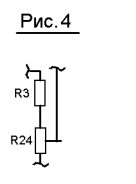
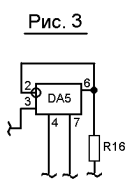
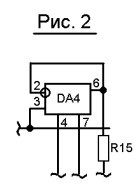
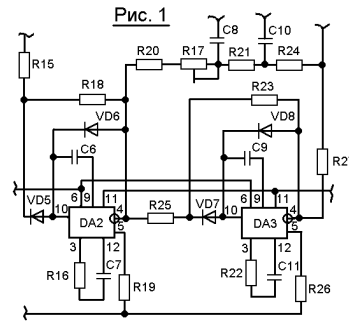

\* Подбирается при регулировании